



# GUIDE DE MONTAGE

## Mise en place du caisson des brûleurs

**IXOBOX** N°10

### Les pièces du kit numéro 37

- 33A** Caisson des brûleurs
- 37B** Séparateur
- 37C** Support
- Vis AP** M1,7 x 4 (2 + 1)

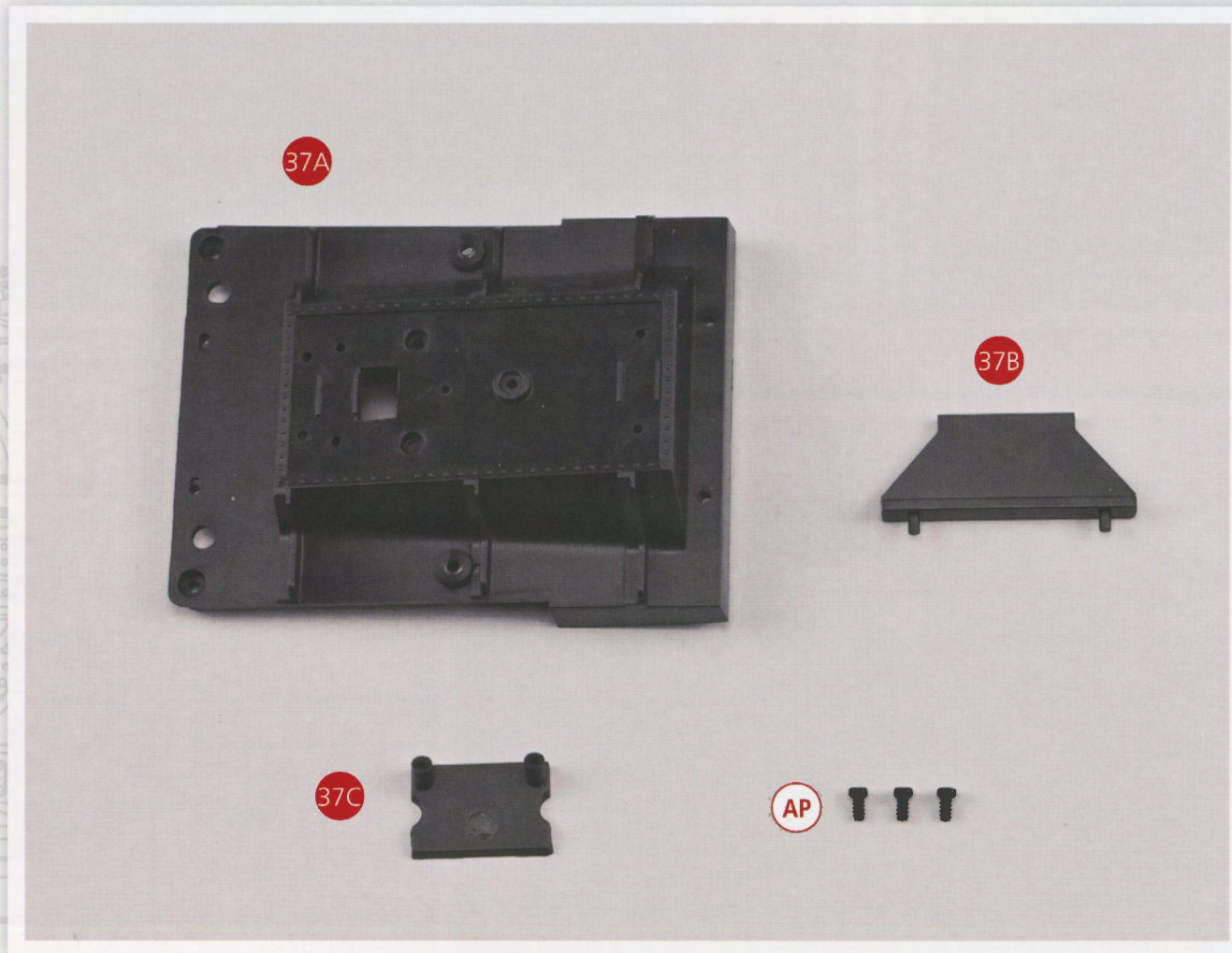

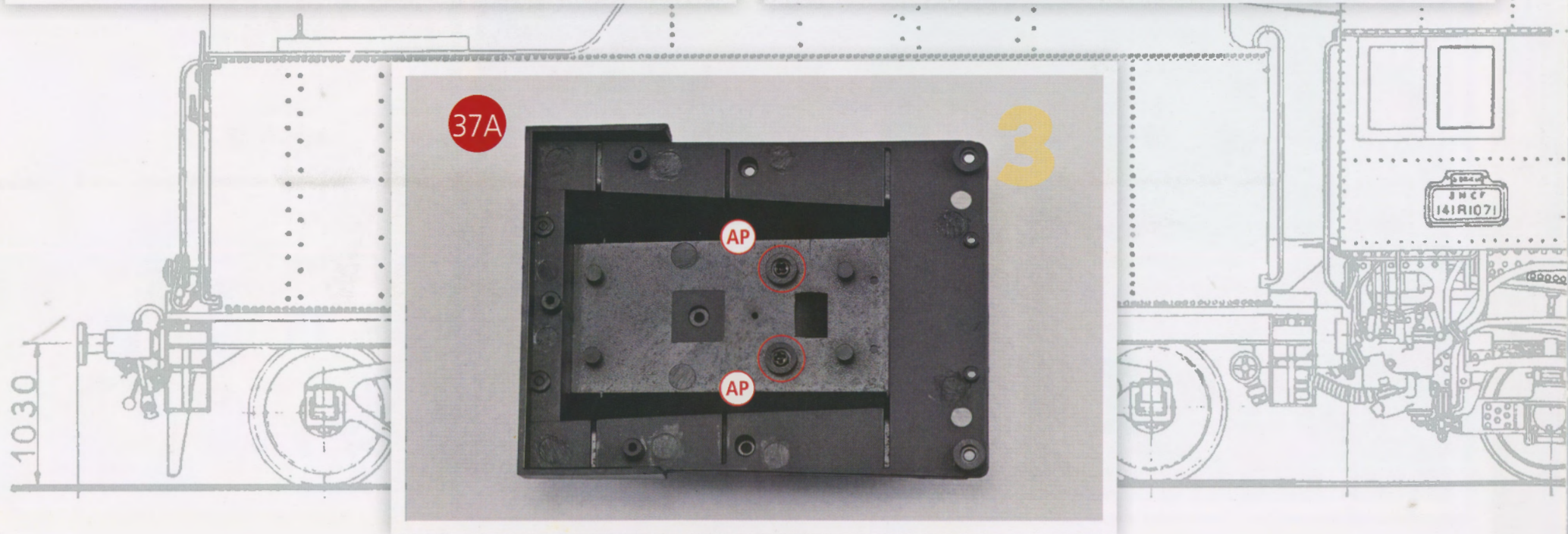
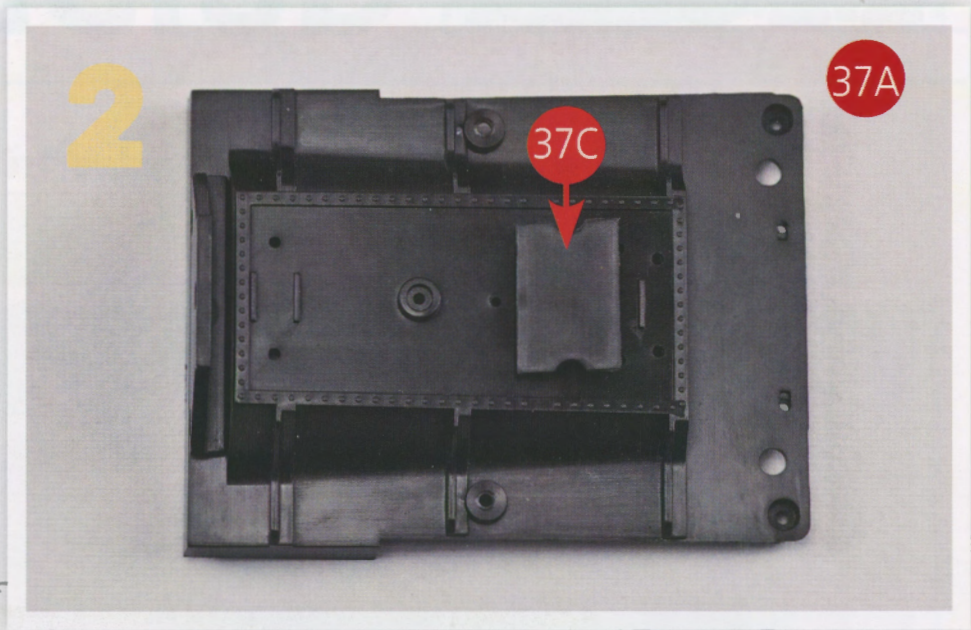
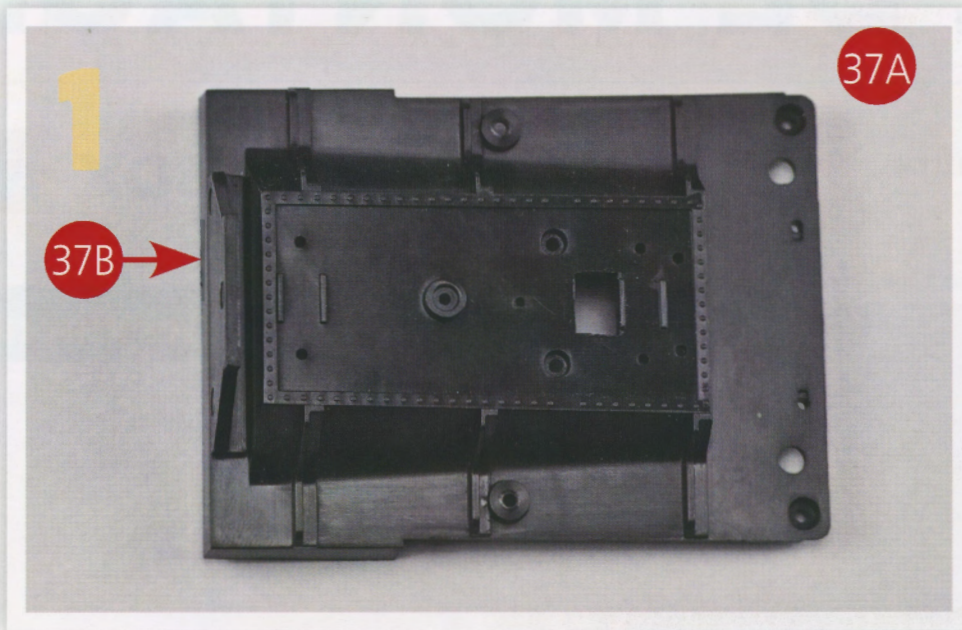

VUE FINALE

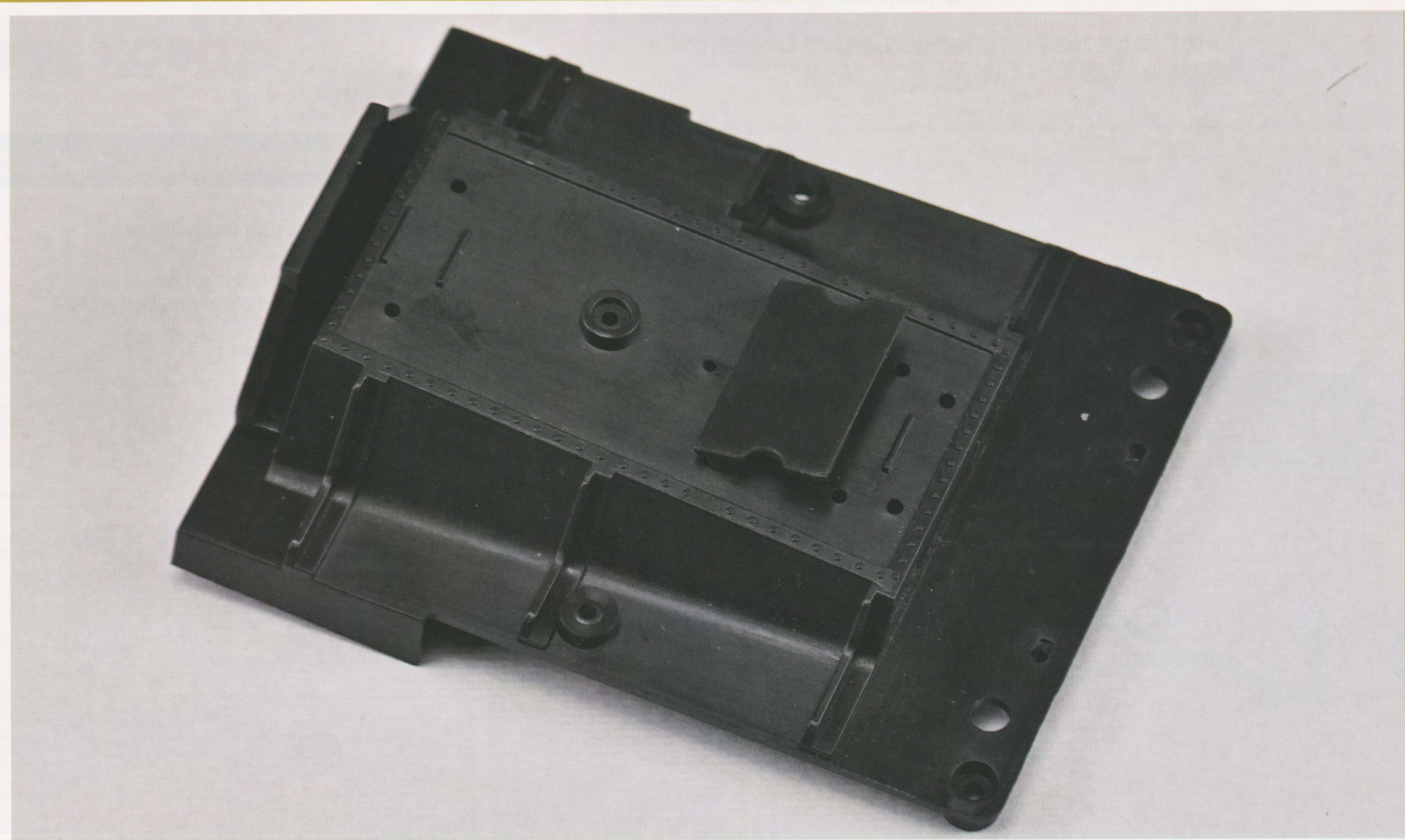



# GUIDE DE MONTAGE

## Montage des accessoires des brûleurs

**IXOBOX** N°10

### Les pièces du kit numéro 38

- 38A** Prise d'air des brûleurs
- 38B** Séparateur
- 38C** Alimentation en fuel
- 38D** Raccord d'alimentation en fuel
- 38E** Support
- Vis AP** M1,7 x 4 (4 + 1)

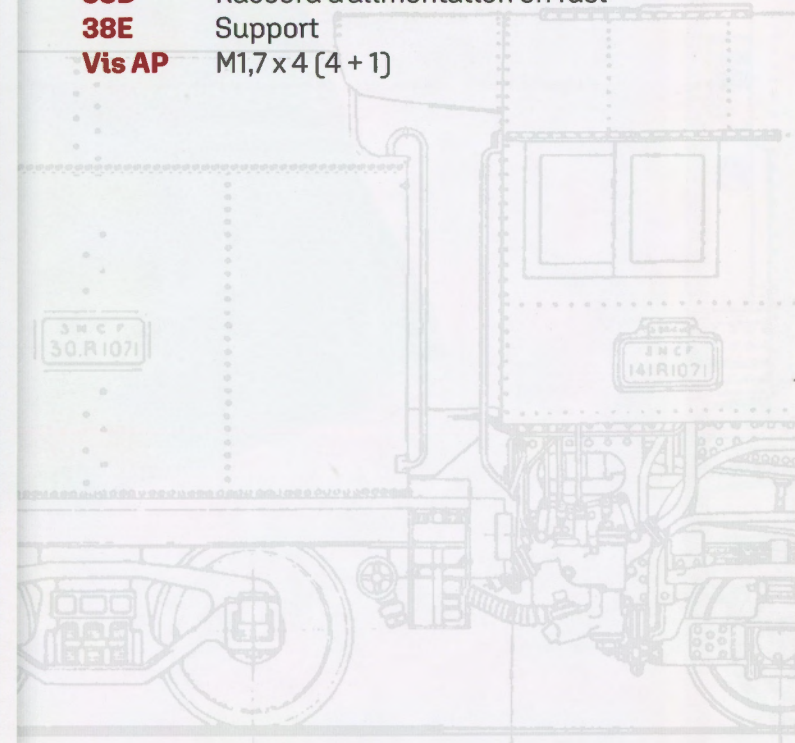
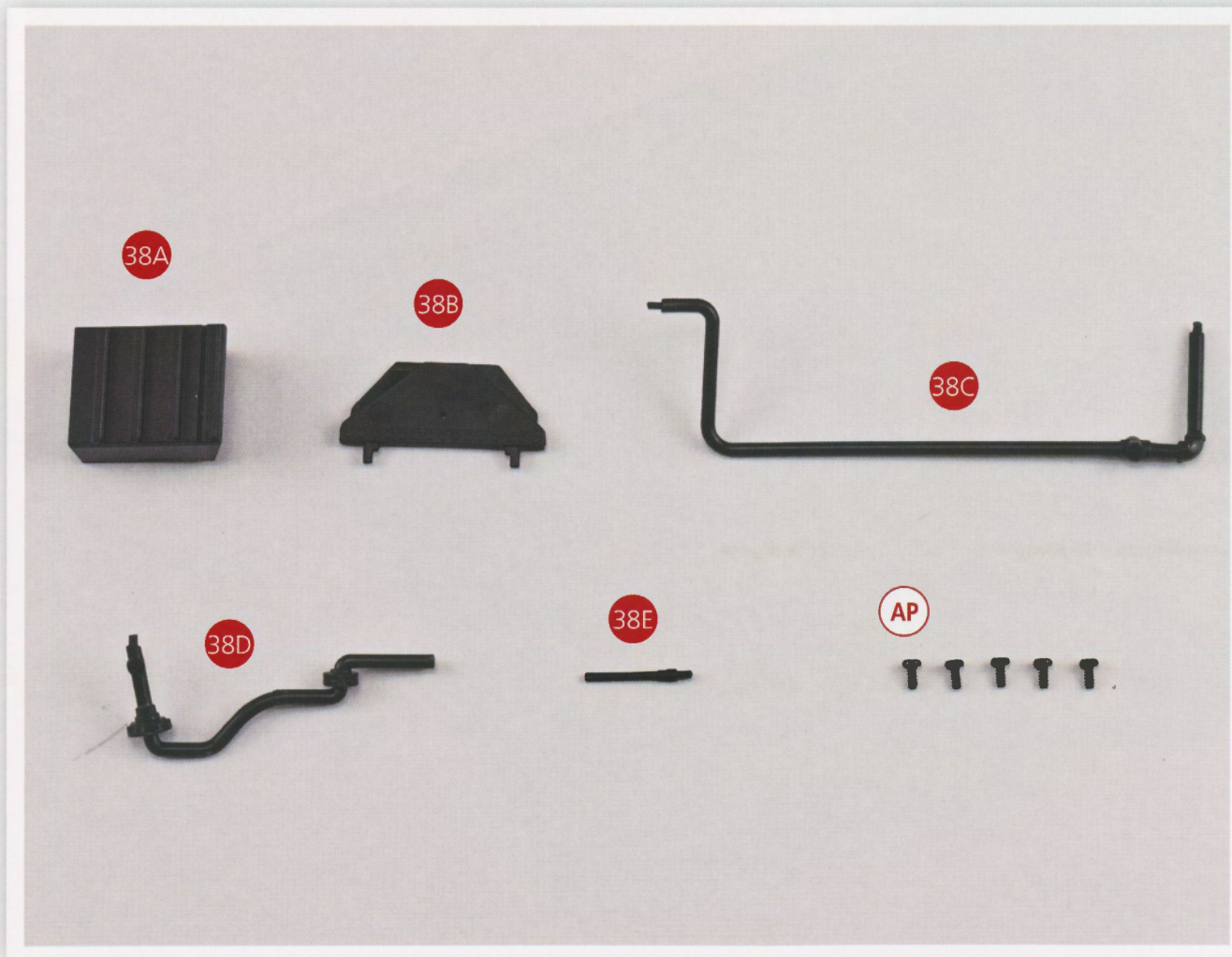

1

38A

37A

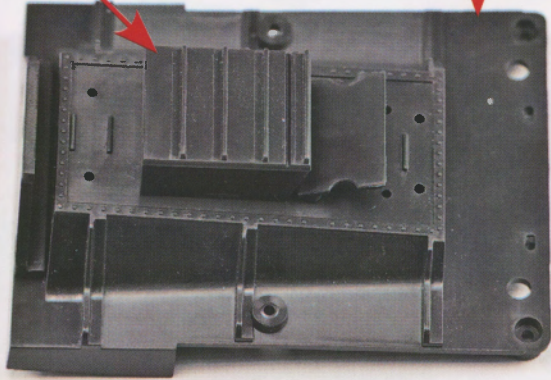

2

AP

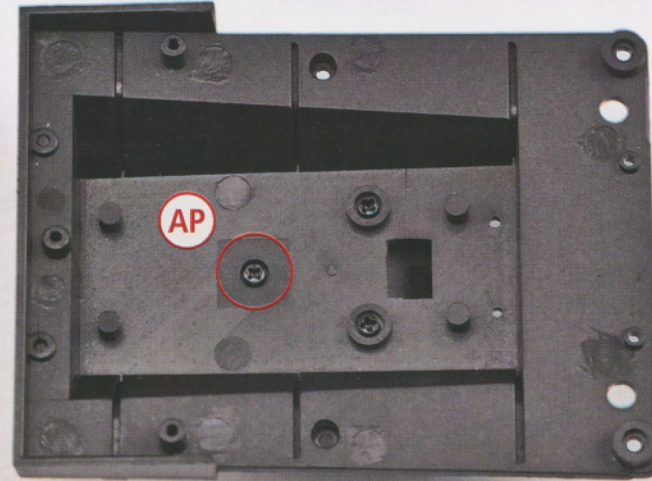

3

38B

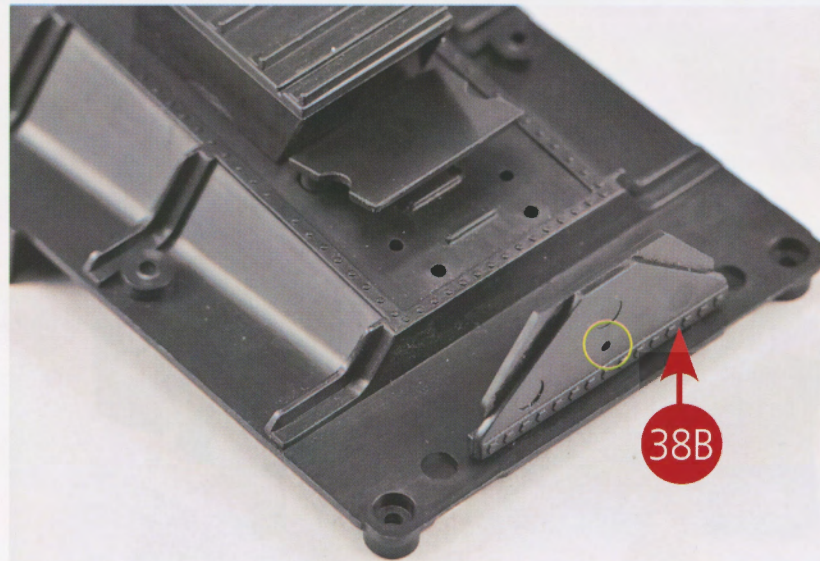

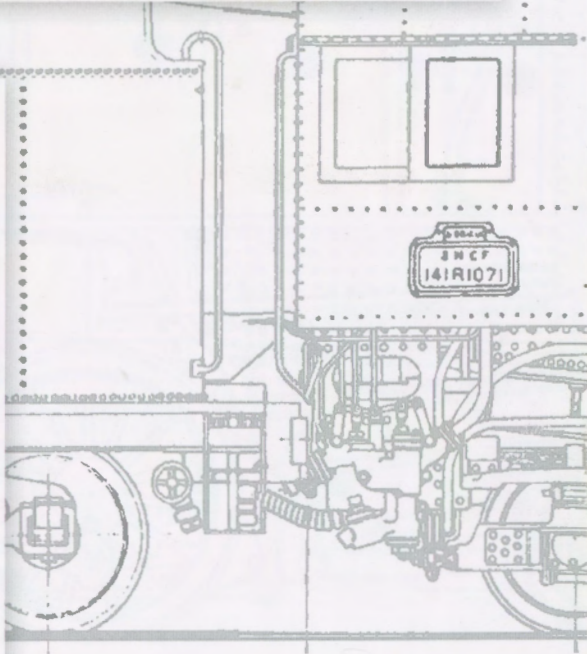
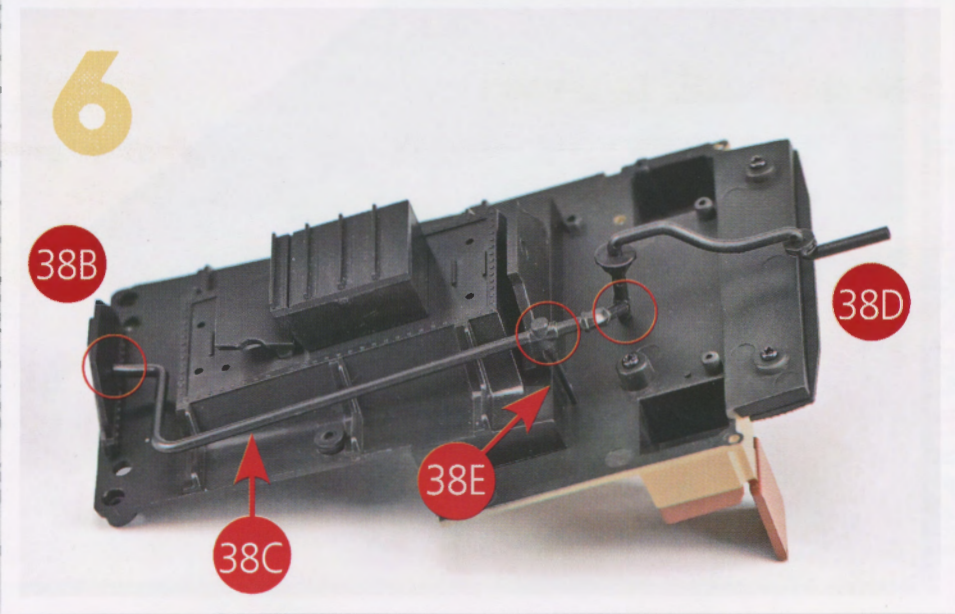
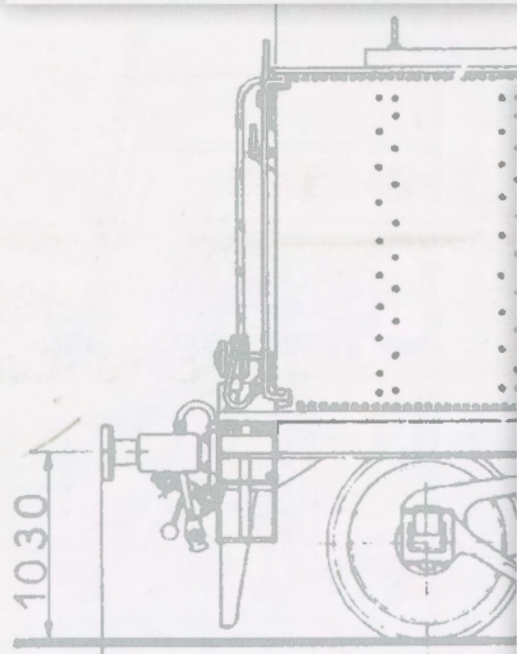
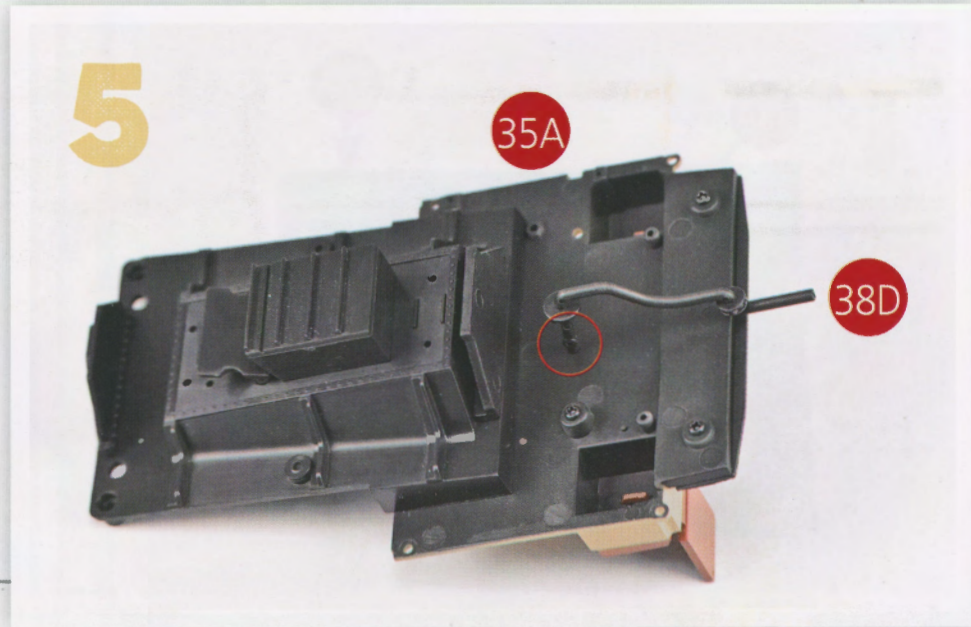
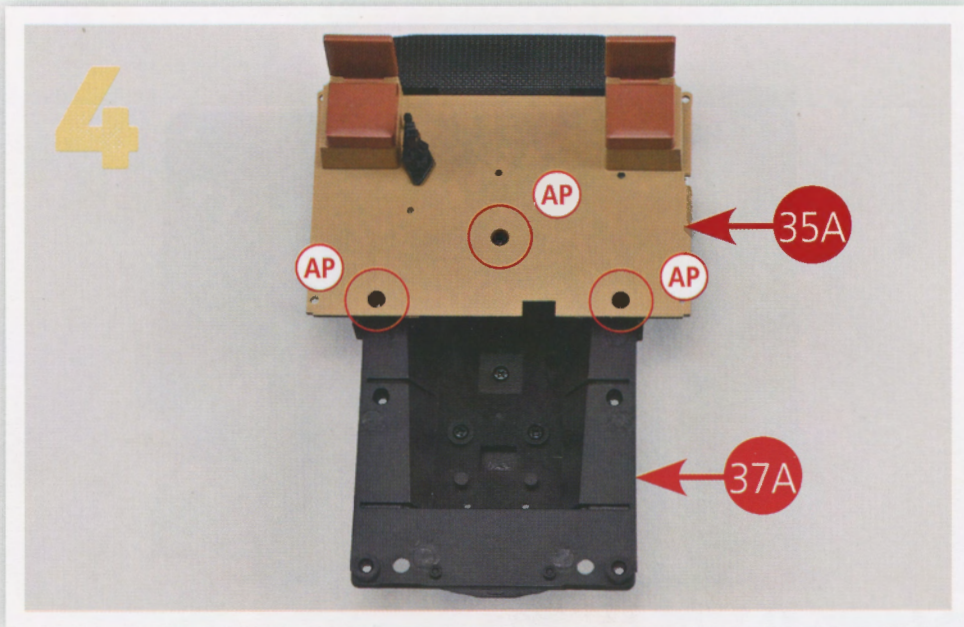

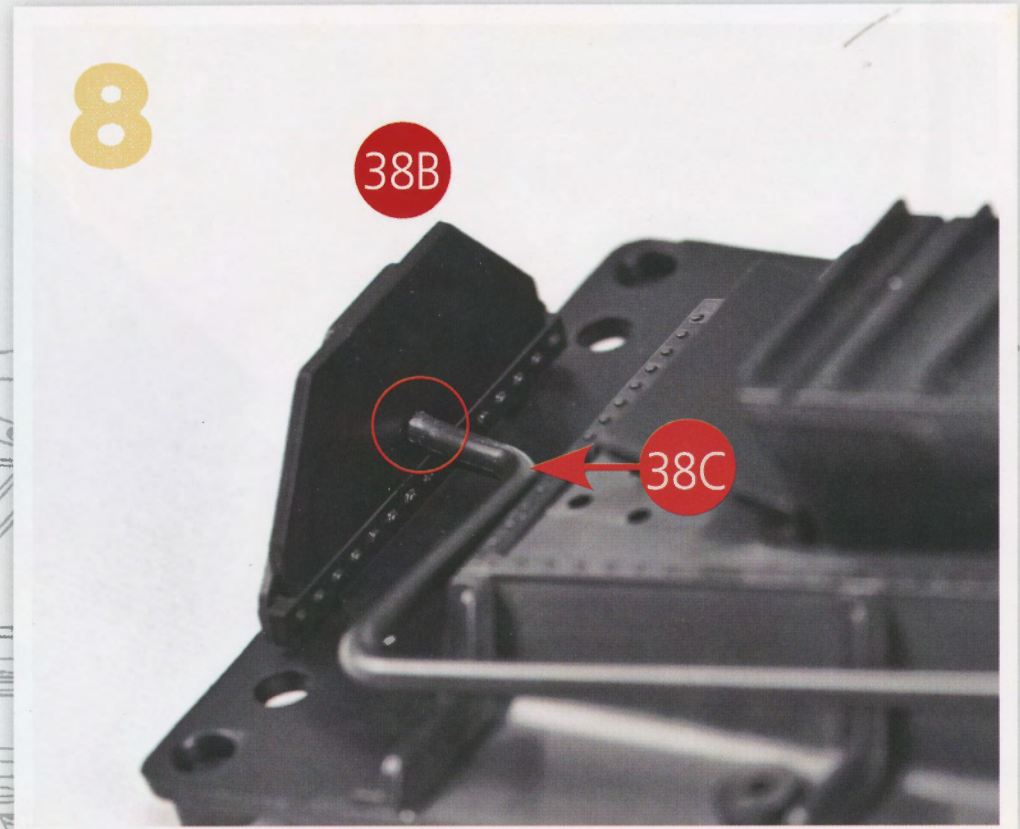
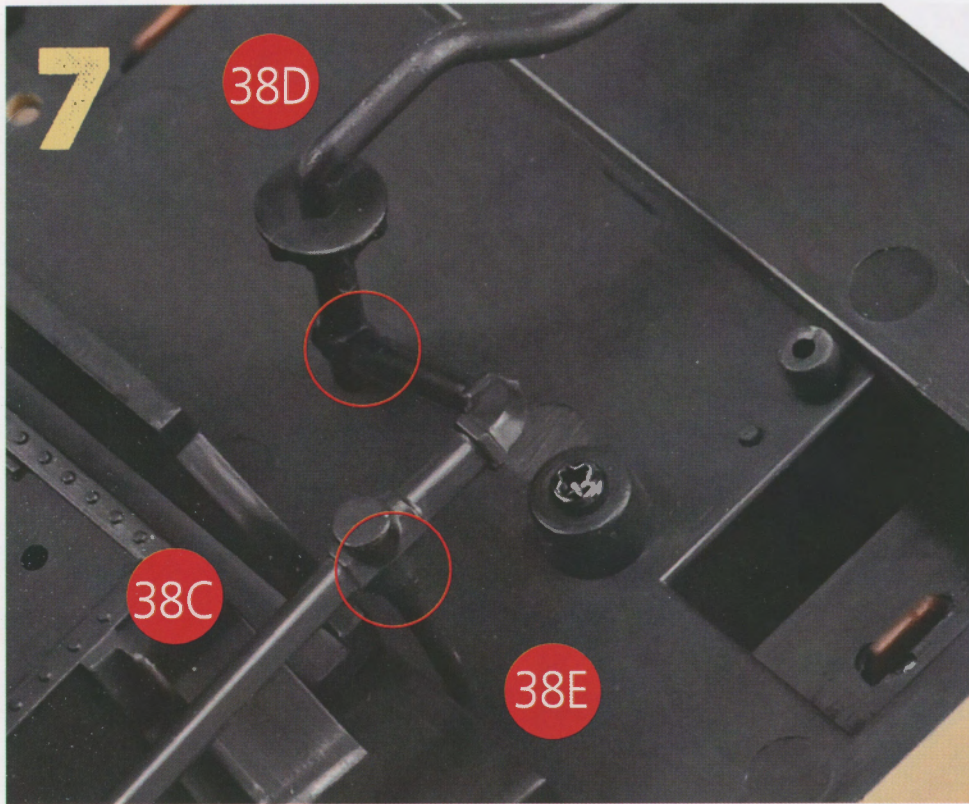

VUE FINALE

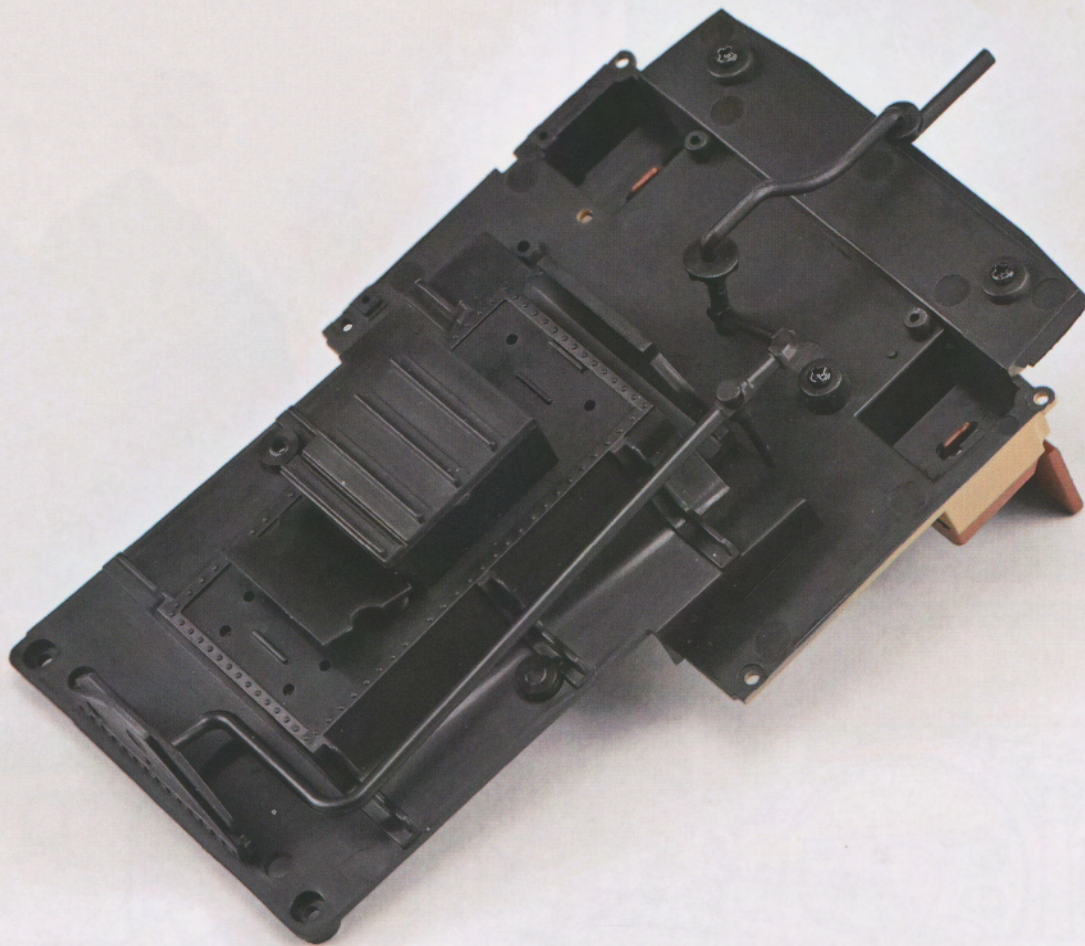





# GUIDE DE MONTAGE

## Mise en place du plateau arrière du châssis

**IXOBOX** N°10

### Les pièces du kit numéro 39

- 39A** Plateau arrière du châssis
- 39B** Supports des conduits de fuel
- Vis AP** M1,7 x 4 (4 + 1)

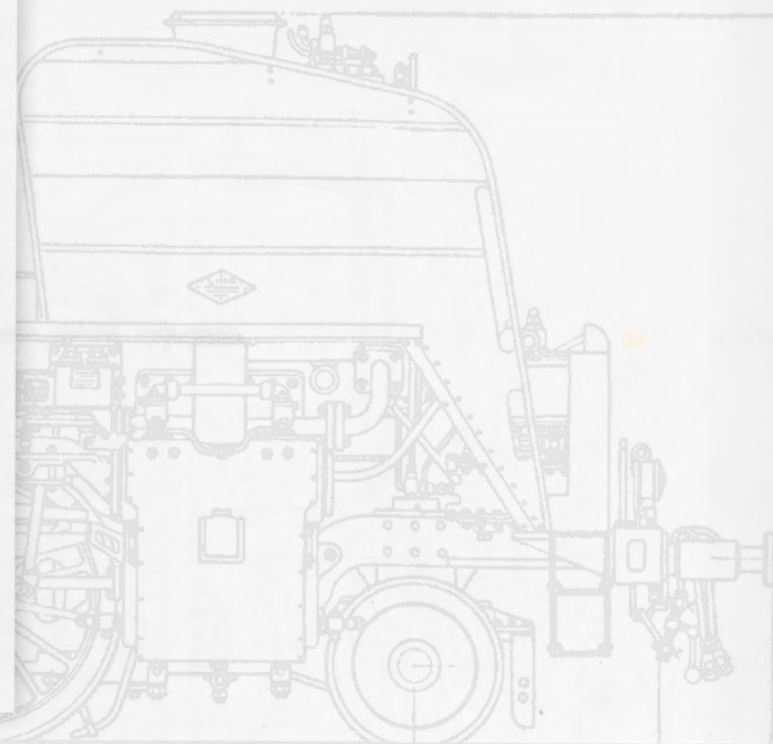
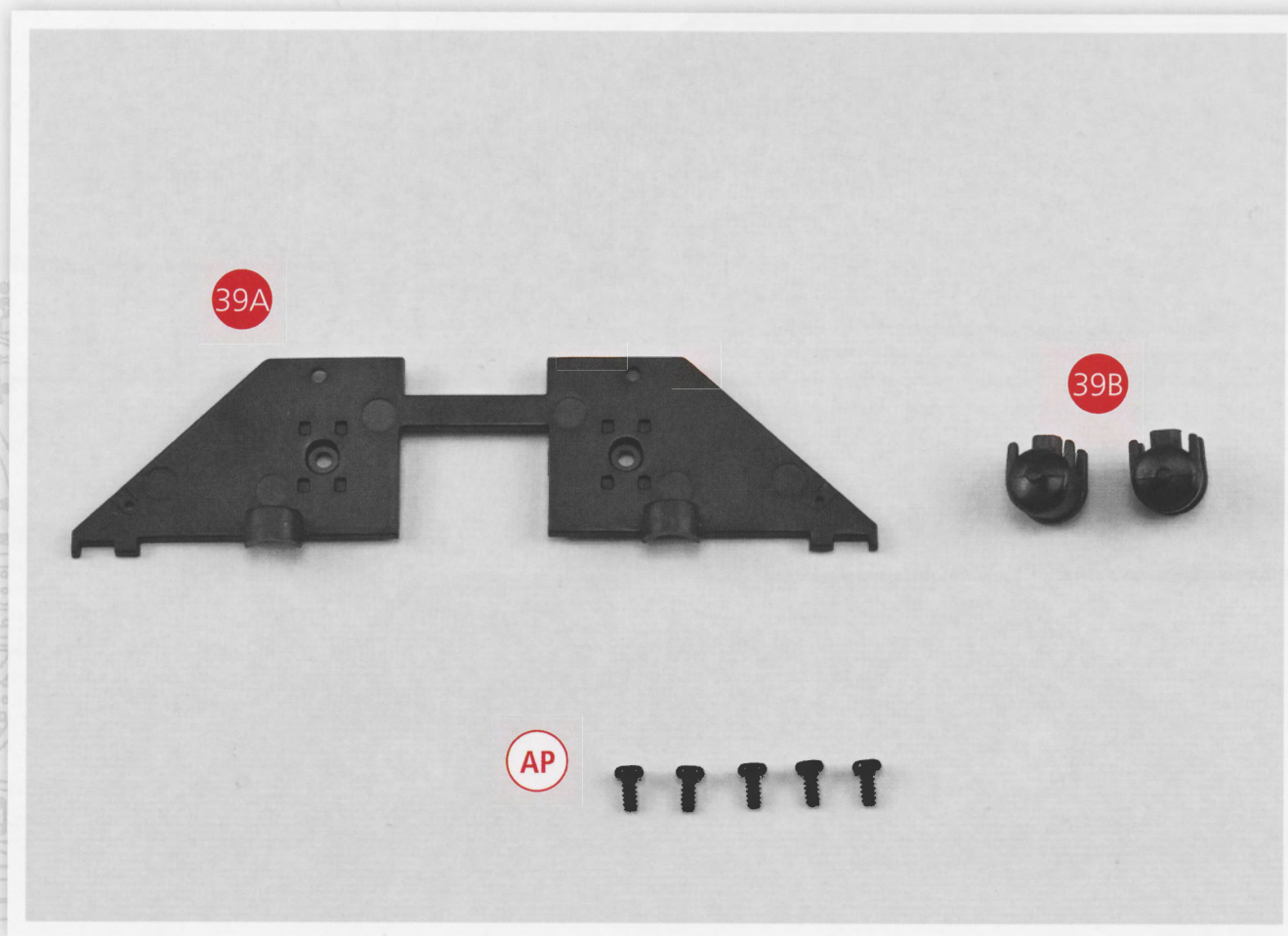

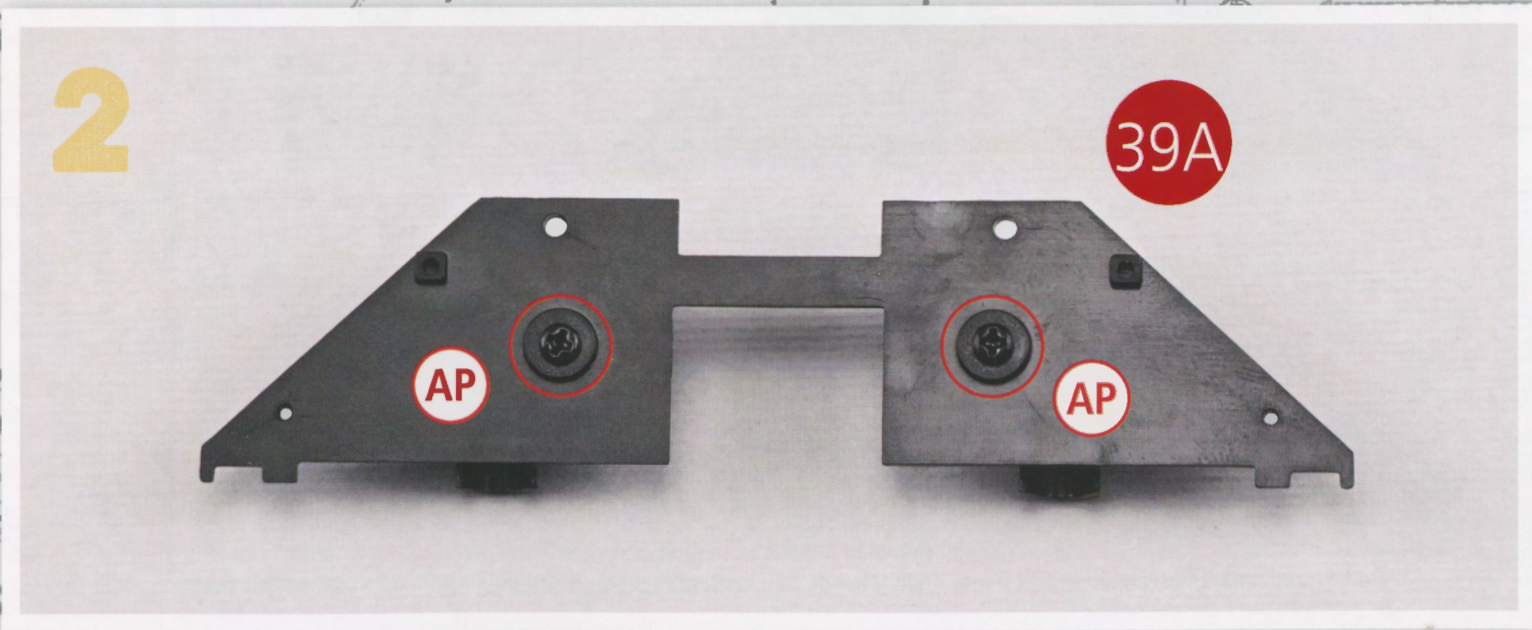
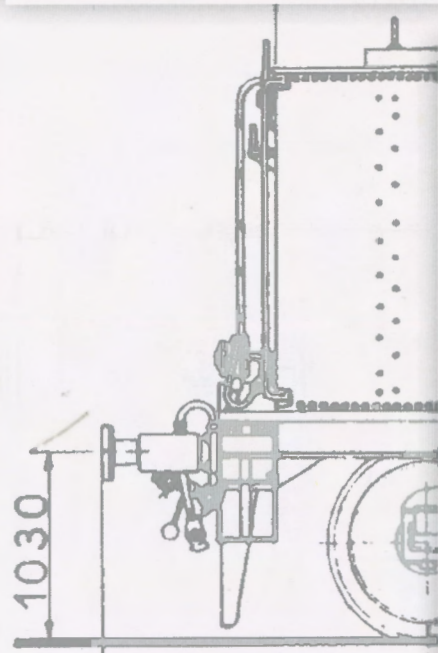
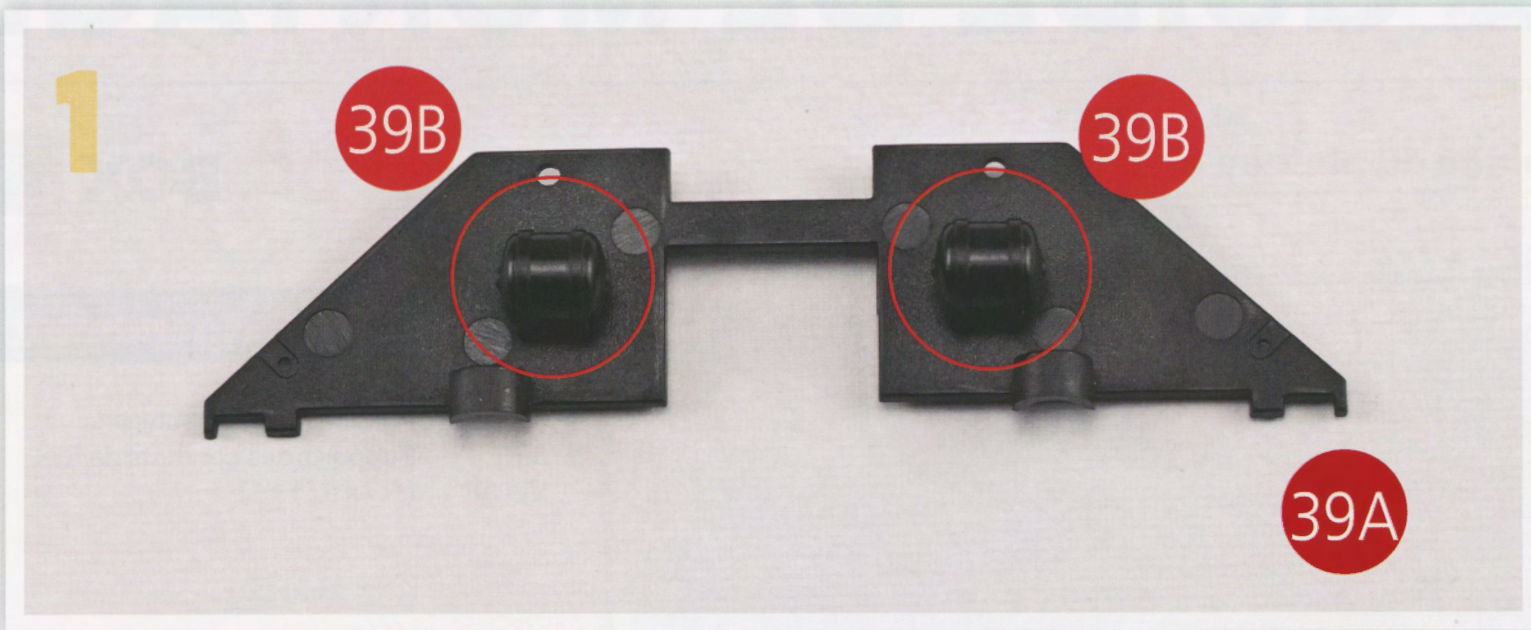

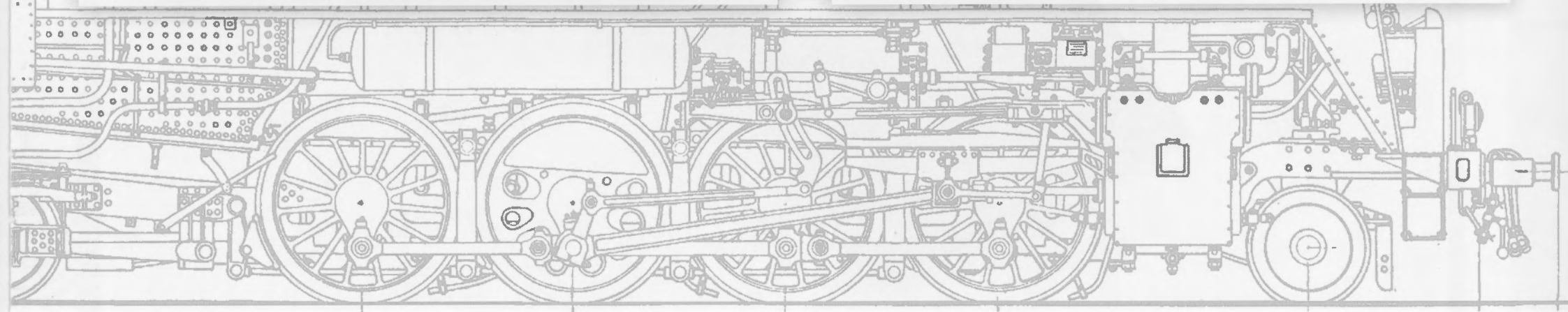
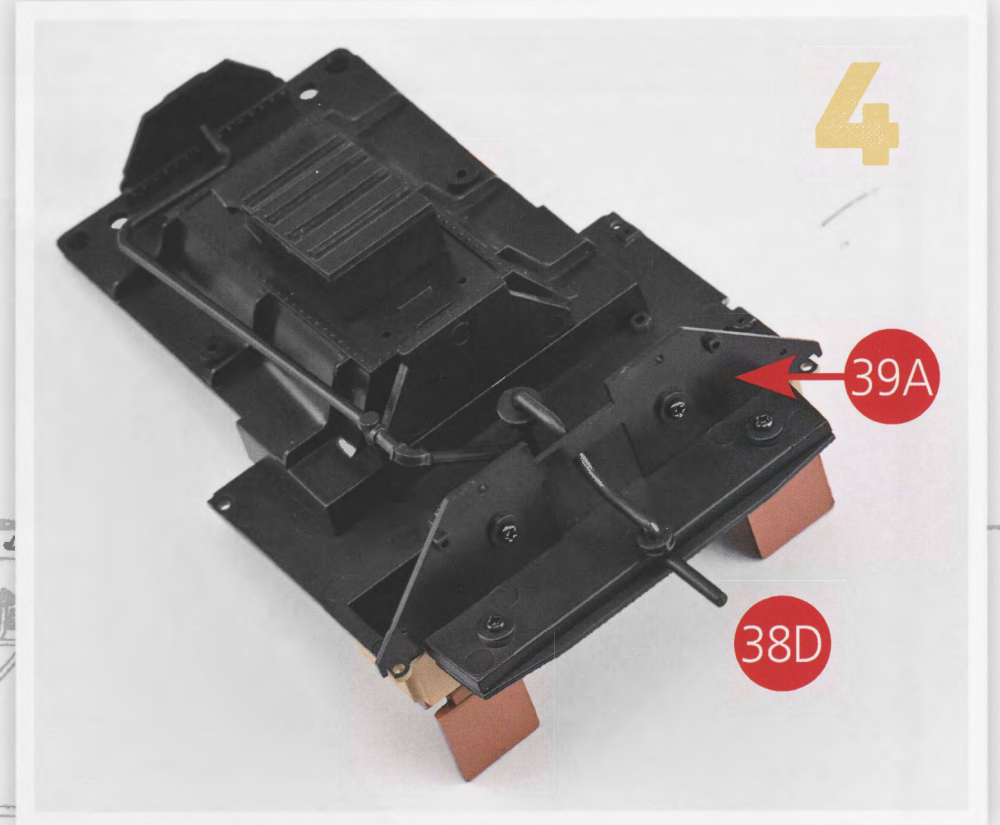
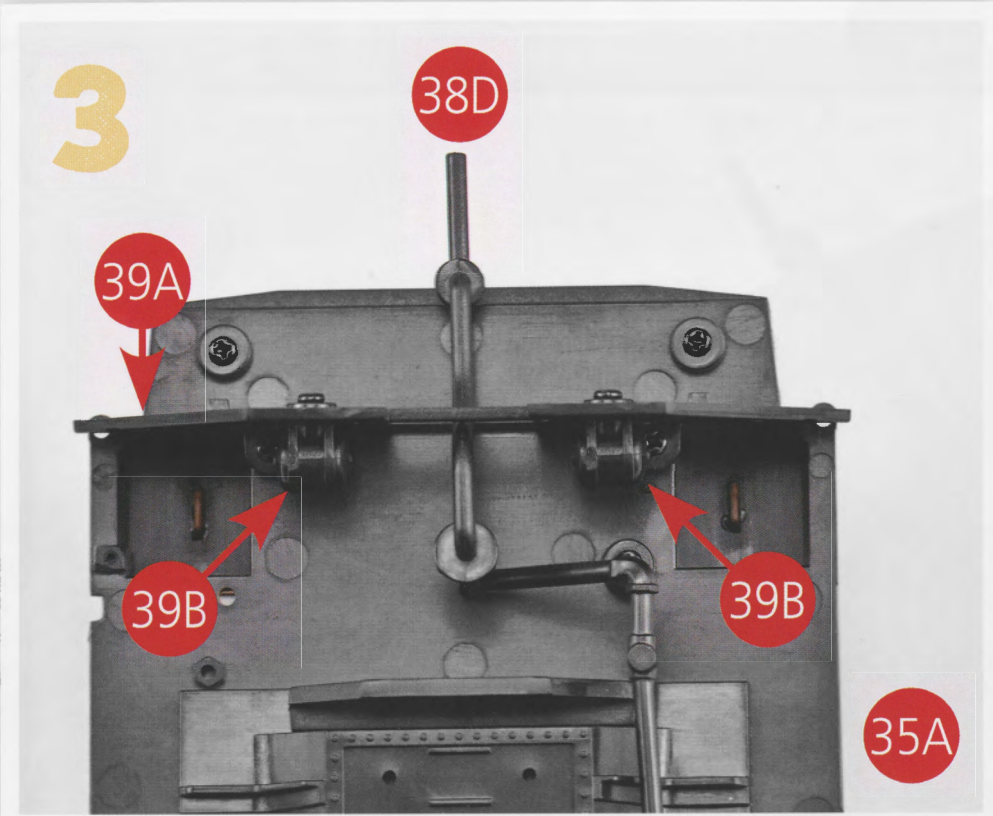

VUE FINALE

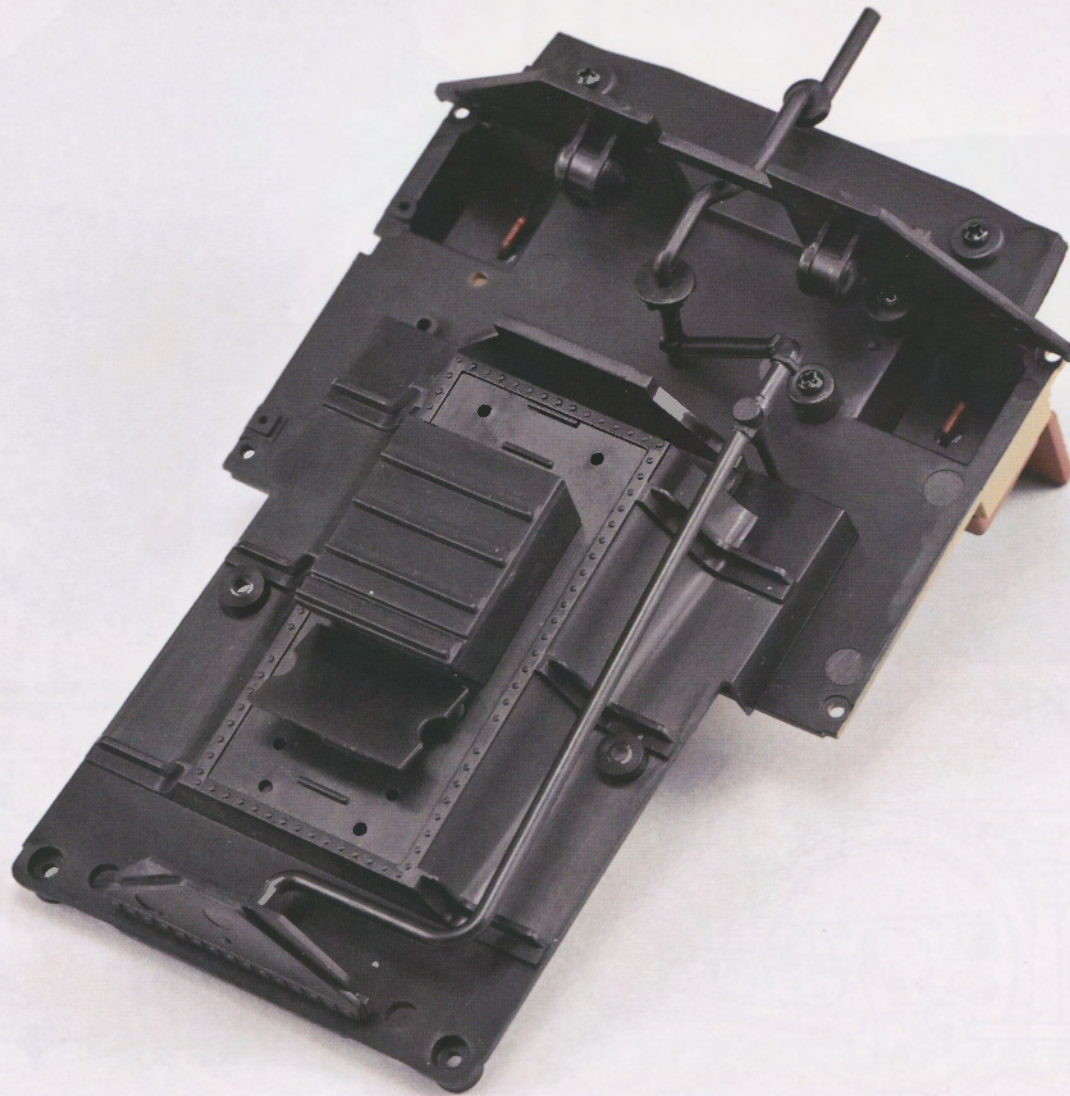



# GUIDE DE MONTAGE

Mise en place des commandes du haut  
de la devanture du foyer

**IXOBOX** N°10

## Les pièces du kit numéro 40

- 40A** Rampe supérieure des commandes
- 40B** Vannes 1 x 4
- 40C** Vannes 2 x 3
- 40D** Vannes 3 x 5

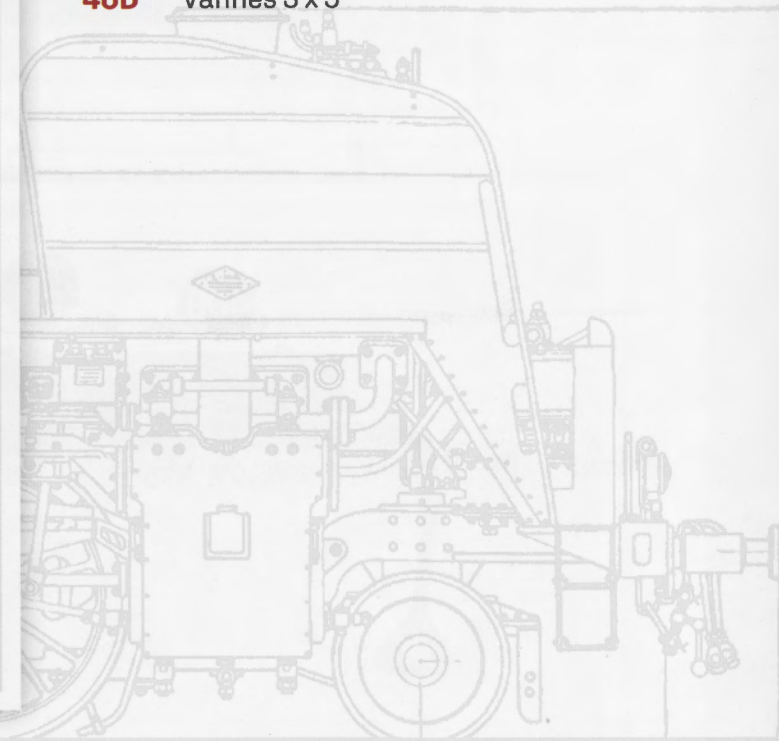
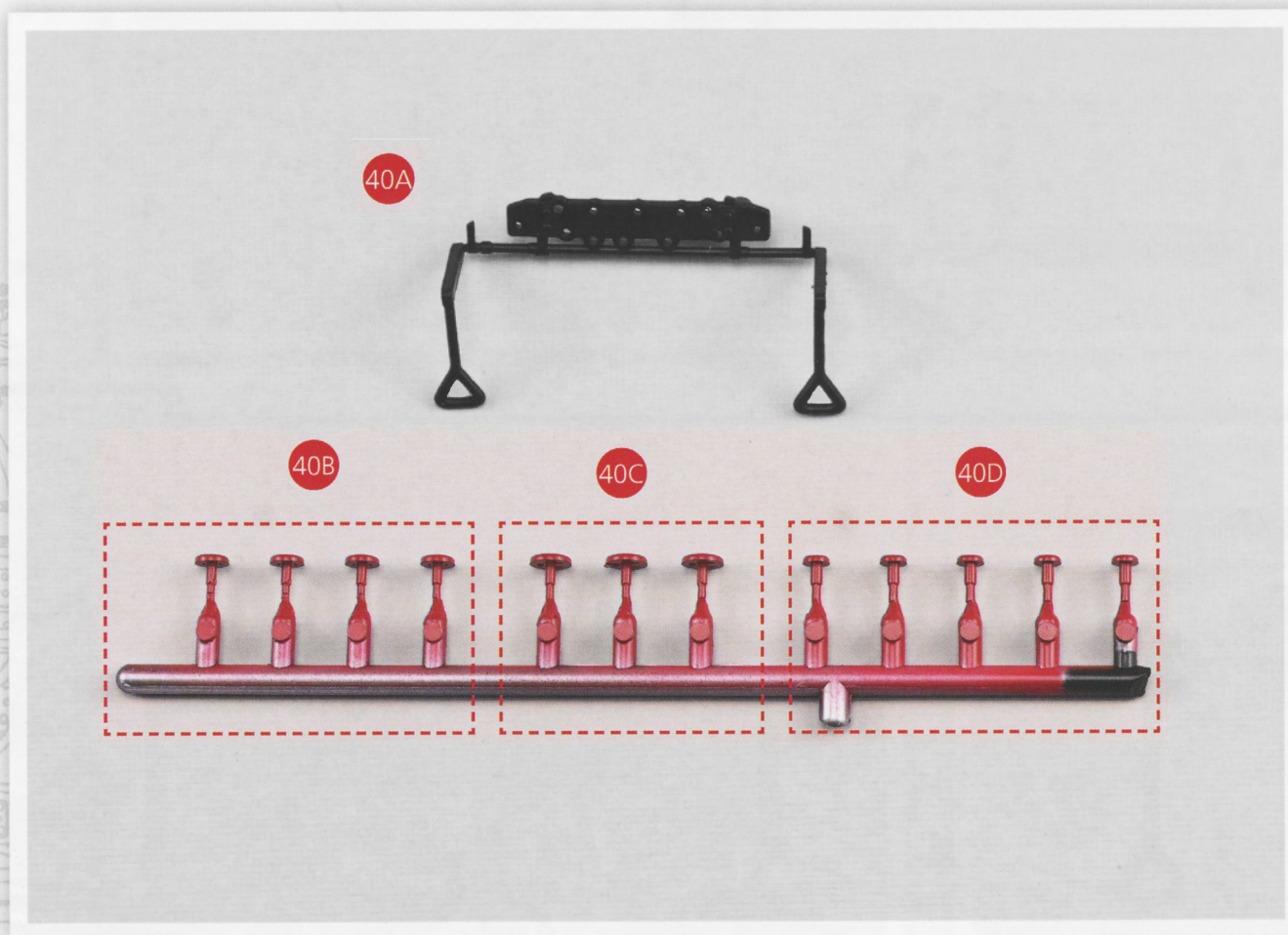

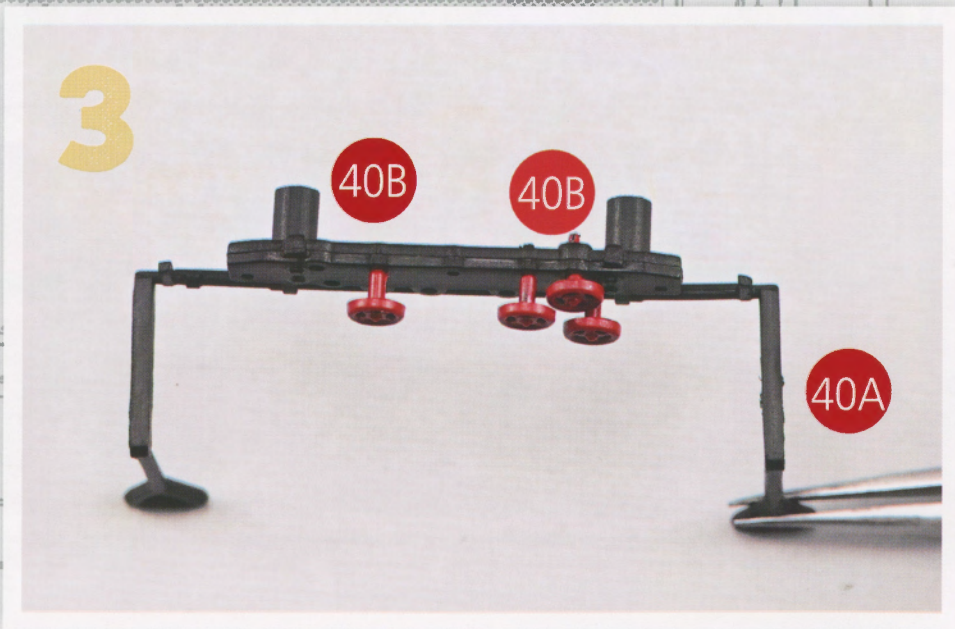
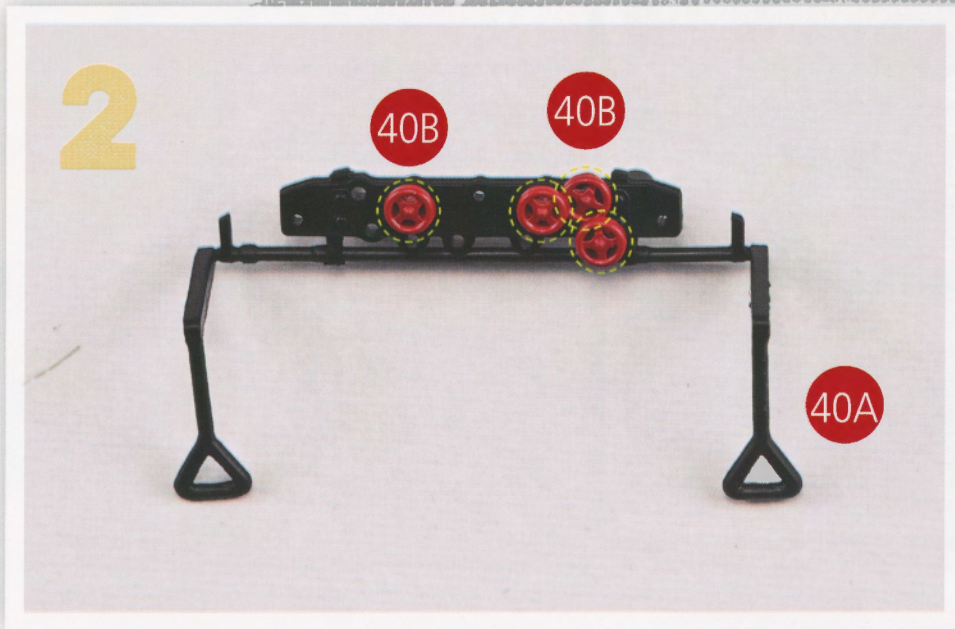
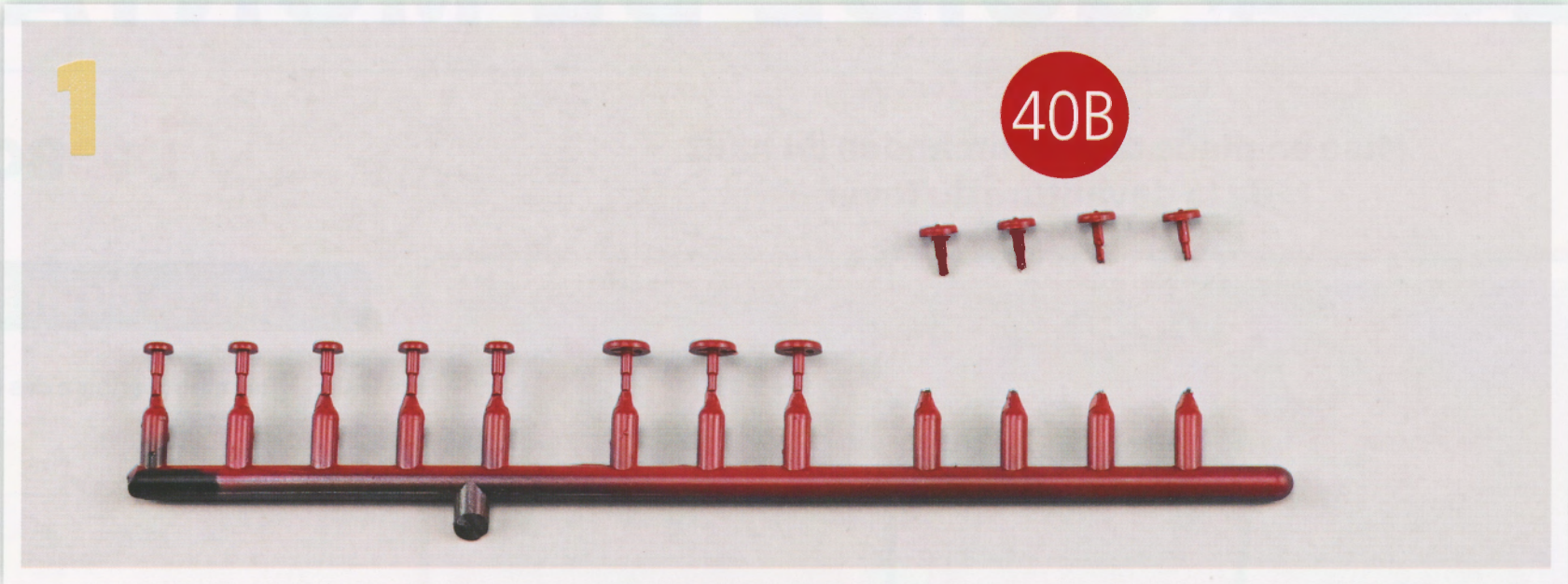

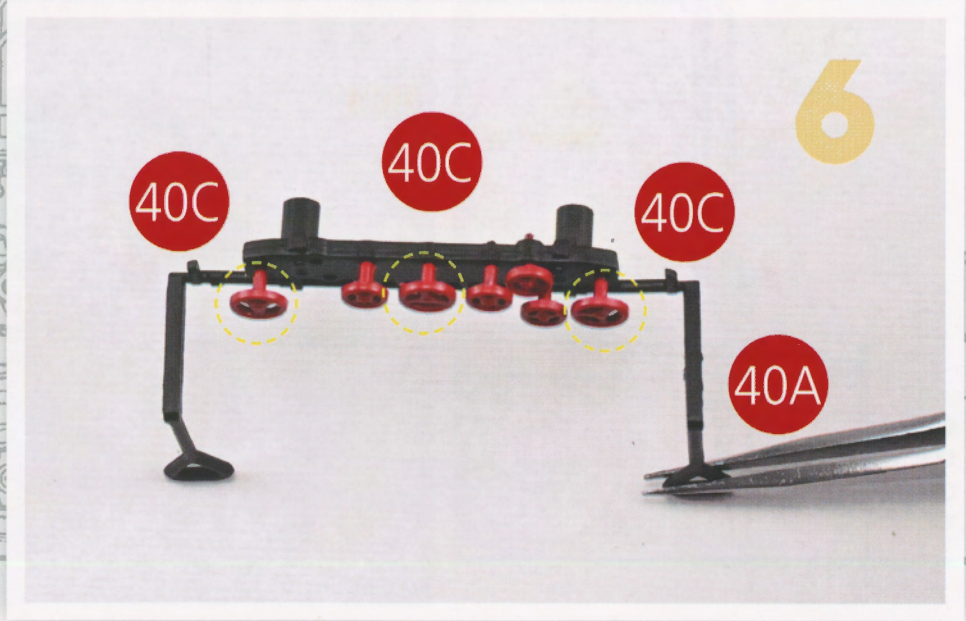
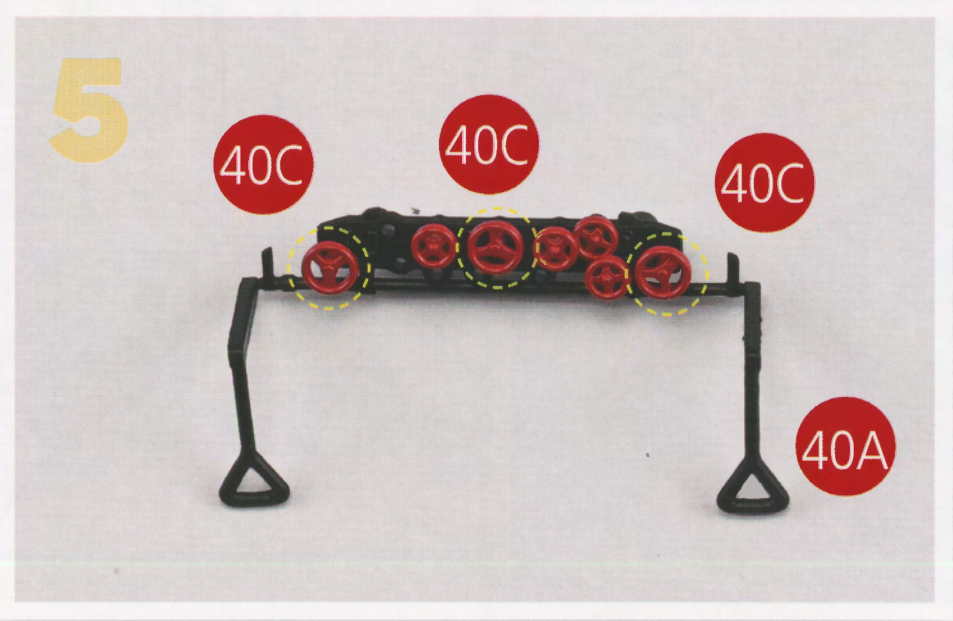
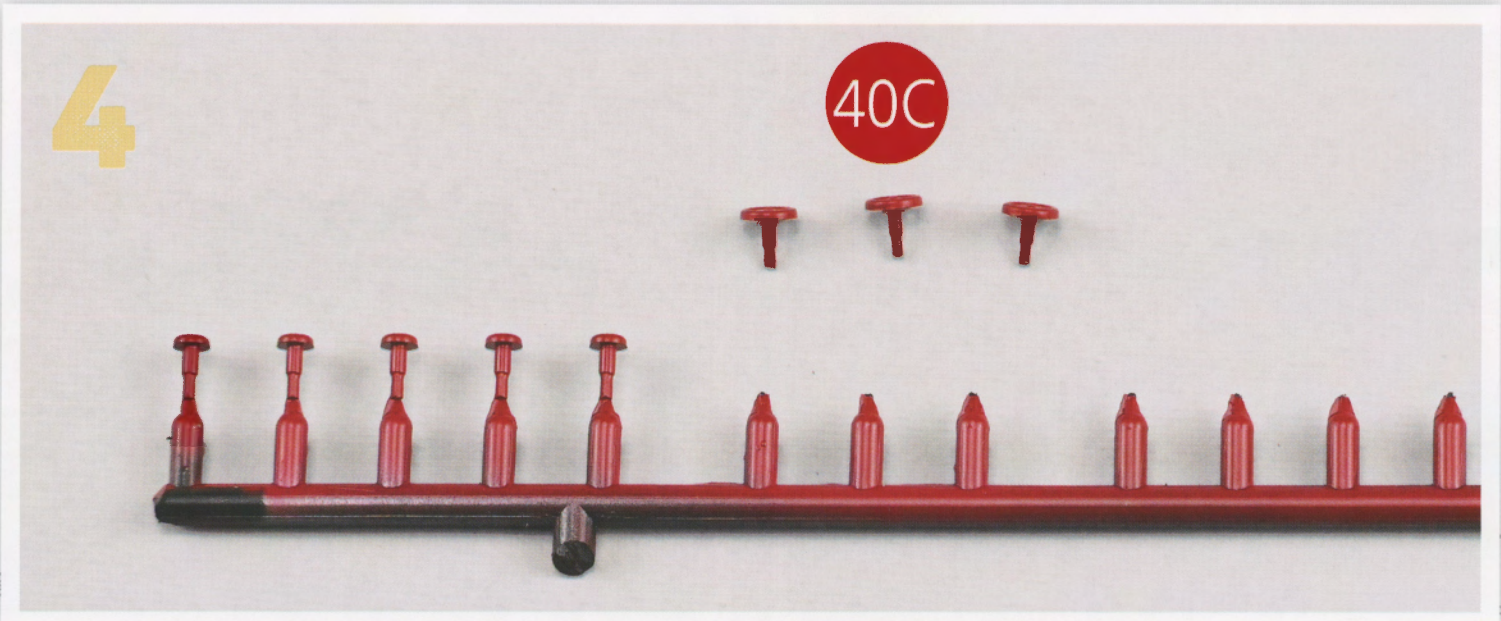

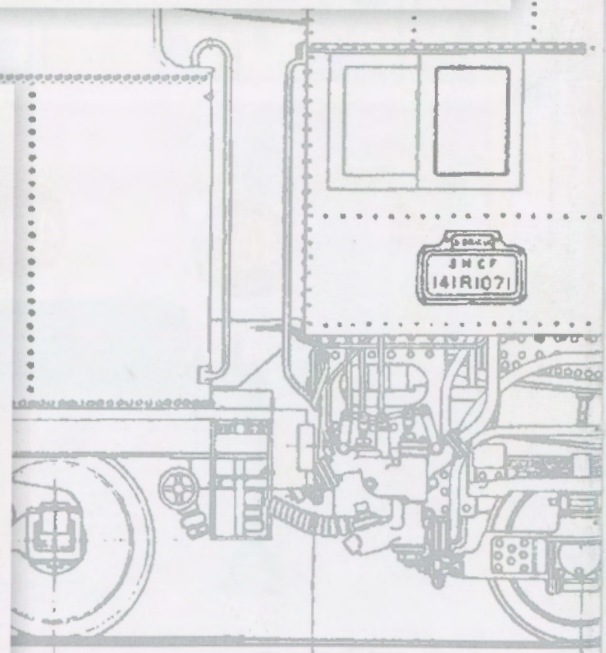
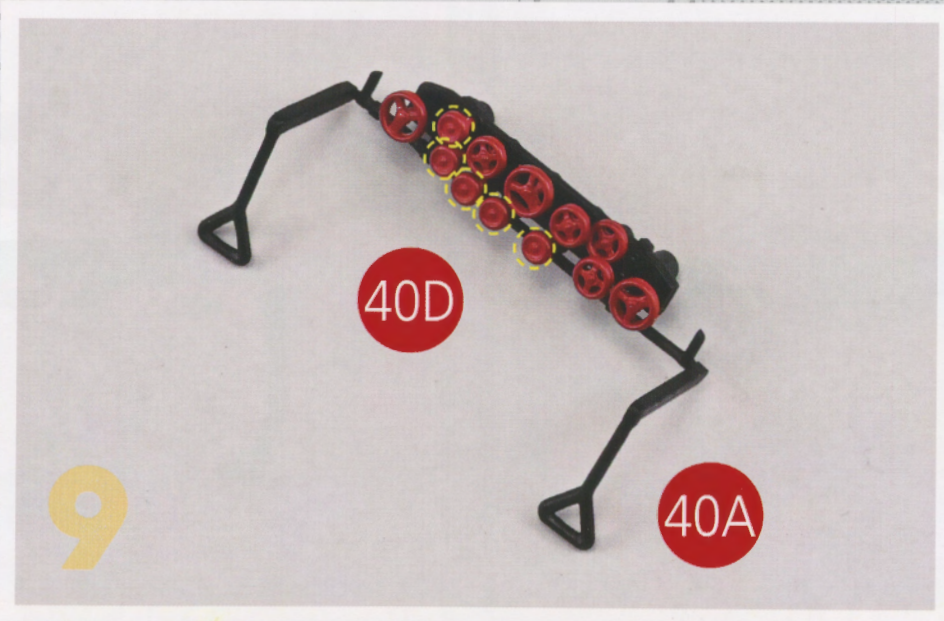
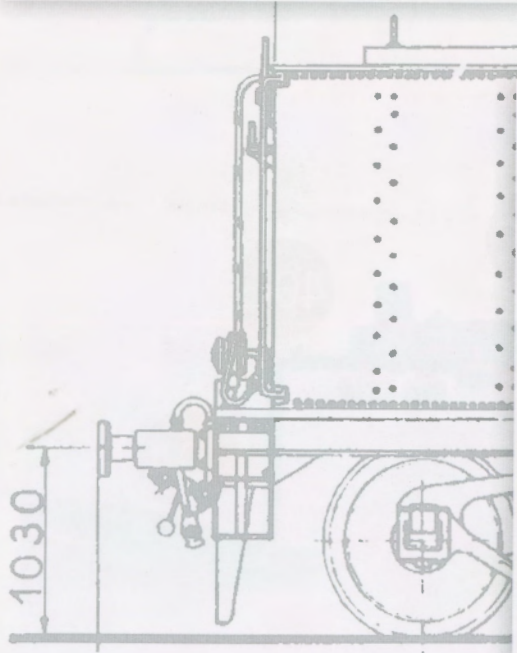
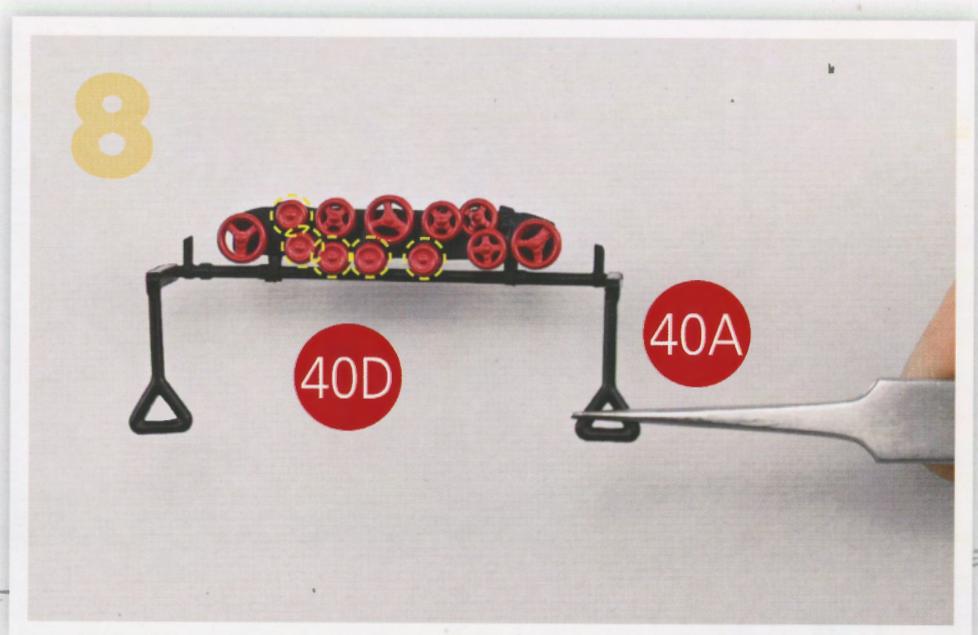
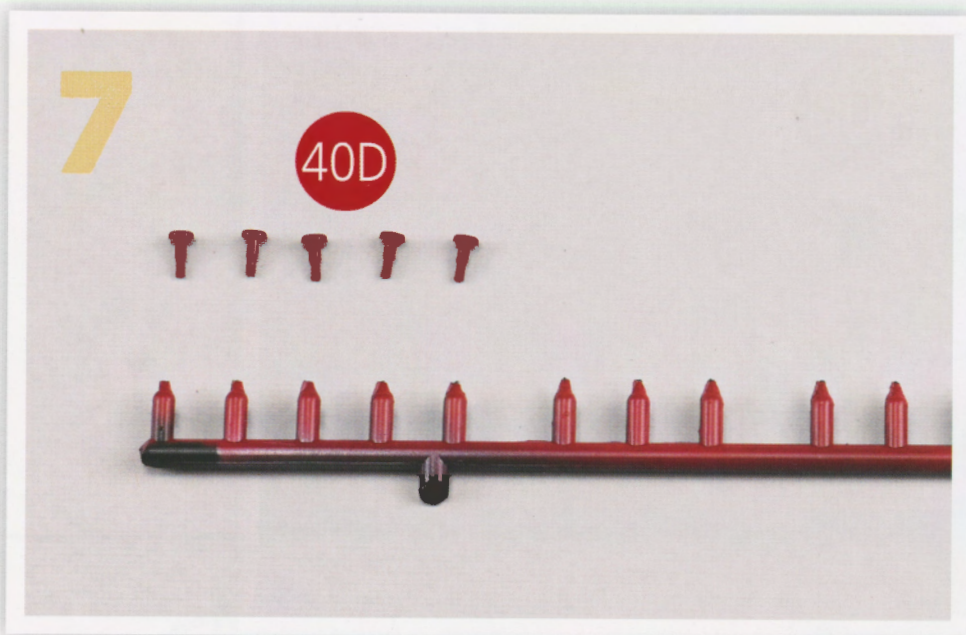



VUE FINALE

